



## **2SG - porte automatiche per ascensori e montacarichi**

Da oltre 40 anni la 2SG produce porte automatiche per ascensori e montacarichi. Oggi un riferimento per molte aziende italiane ed estere.

Un prodotto semplice e di qualità, un sistema certificato ISO 9001-2015, in grado di soddisfare le esigenze del cliente di migliorare le proprie capacità di adattamento ad un mercato sempre più globale e frammentato.

- “ Operatori elettronici semplici ed affidabili “
- “ Operatori meccanici in pronta consegna “
- “ Operatori per impianti semiautomatici con pattino retrattile “
- “ Operatori per impianti con stazionamento a porte aperte “
- “ Operatori compatibili con la maggioranza delle sospensioni in commercio “
- “ Porte di piano complete “
- “ Telai su misura minimo 30 mm “
- “ Soglie di piano e cabina ridotte - Soglie rinforzate “
- “ Porte di piano certificate EI 120 conformi alla EN 81.20 “
- “ Grandi porte per montacarichi “
- “ Soluzioni customizzate “

**Via Primo Maggio 13/15 20885 Ronco Briantino Monza Italia**

**Tel. +39 039 6079061 Monza**

**Tel. +39 0823 683470 Caserta**

**Mob. +39 348 6611150**

**www.2sg.it info@2sg.it a.cioffi@2sg.it**

## **2SG - automatic doors for lifts and goods hoist**



For over 40 years 2SG has been producing automatic doors for lifts and goods hoist. Today it is a reference for many Italian and foreign companies.

A simple and quality product, an ISO 9001-2015 certified system, able to meet customer needs and improve its ability to adapt to an increasingly global and fragmented market.

- “ Simple and reliable electronic door operators “
- “ Mechanical door operators ready for delivery “
- “ Operators for semi-automatic systems whit retractable slide “
- “ Operators for systems whit open door parking “
- “ Operators compatible whit the majority of landings mechanism on the market “
- “ Complete landing doors “
- “ Customized frames - minimum 30 mm “
- “ Lower floor and cabin sill - Reinforced sill
- “ EI 120 certified landing doors conforming to EN 8120 “
- “ Large doors for freight elevators “
- “ Custom solutions “

**Via Primo Maggio 13/15 20885 Ronco Briantino Monza Italia**

**Tel. +39 039 6079061 Monza**

**Tel. +39 0823 683470 Caserta**

**Mob. +39 348 6611150**

**[www.2sg.it](http://www.2sg.it) [info@2sg.it](mailto:info@2sg.it) [a.cioffi@2sg.it](mailto:a.cioffi@2sg.it)**

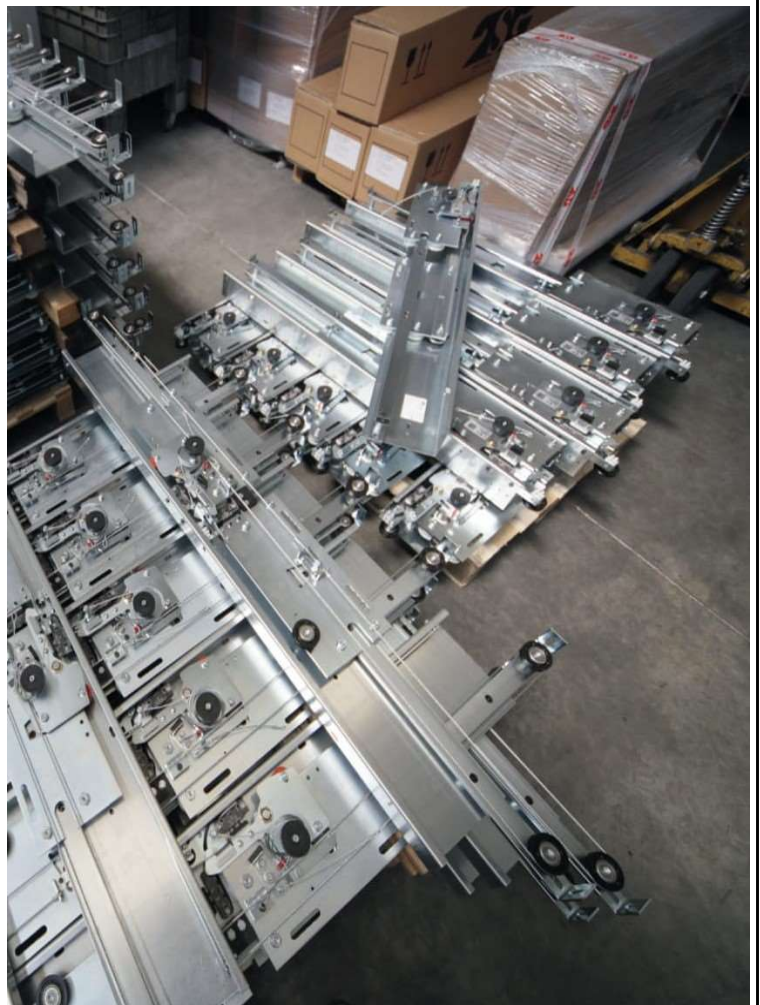

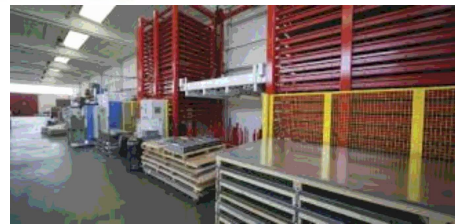

PORTE PANORAMICHE - PANORAMIC DOORS

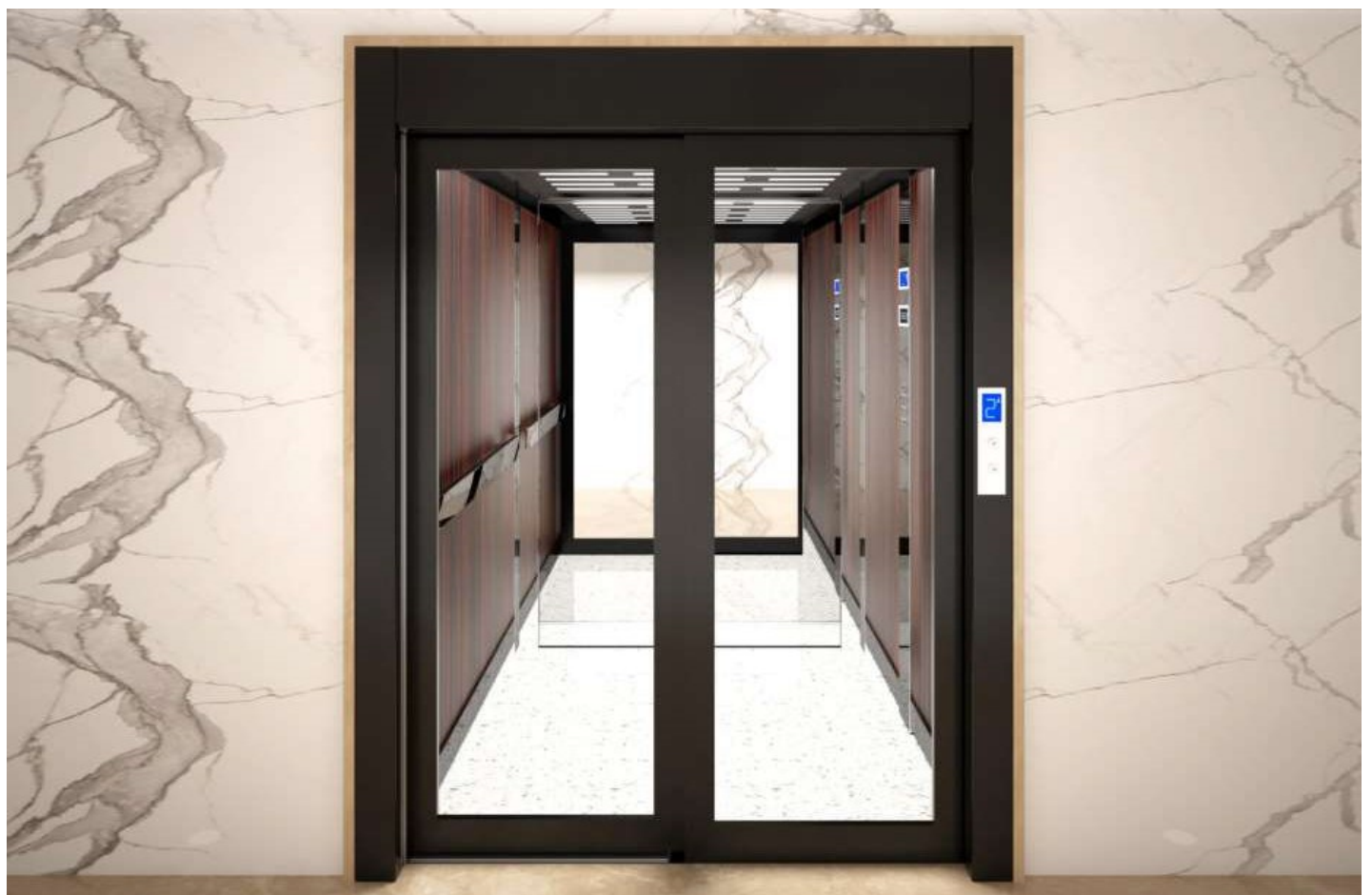

**OPERATORE OP93 2 ANTE CENTRALI 2AO  
CENTRAL 2 PANELS OP 93 DOOR OPERATOR 2AO**

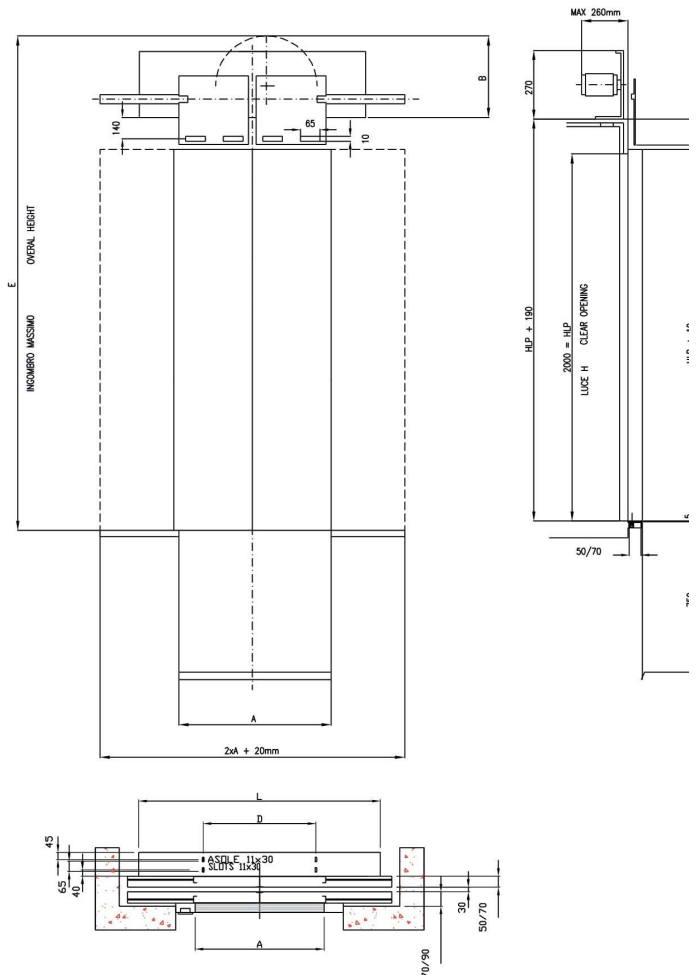
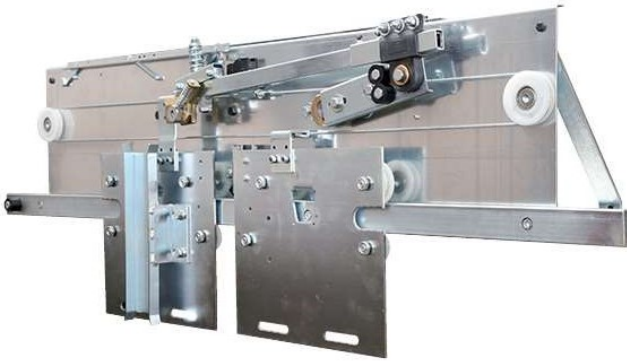

Tabella

A = (mm)	L = (mm)	D = (mm)	B = (mm)	E = (mm)
500	1100	600	385	2575
550	1100	600	395	2585
600	1100	600	415	2605
650	1100	600	410	2600
700	1250	700	420	2610
750	1250	700	435	2625
800	1500	800	445	2635
850	1500	800	460	2650
900	1500	800	470	2660
950	1500	800	485	2675
1000	2000	1200	495	2685
1100	2000	1200	520	2710
1200	2000	1200	545	2735
1300	2000	1200	570	2750
1400	2000	1200	595	2785

**OPERATORE OP93 2 ANTE TELESCOPICO 2AT  
TELESCOPIC OP93 2 SIDE DOOR OPERATOR 2AT**

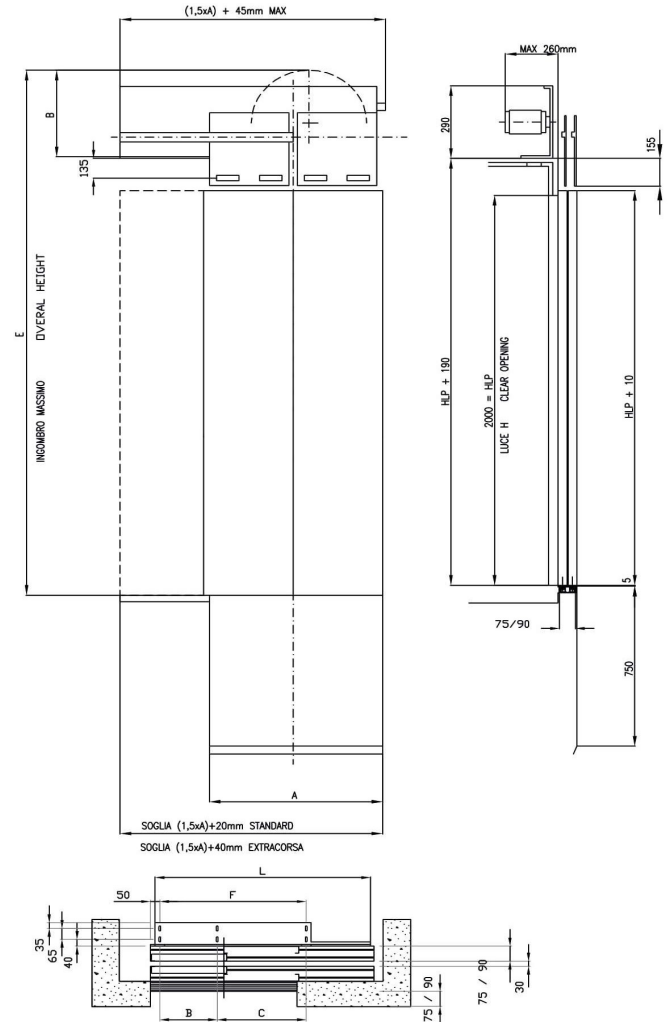
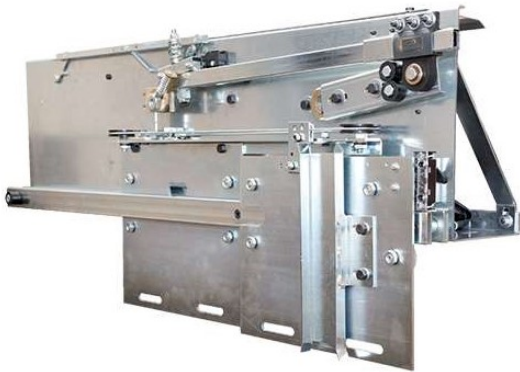

Tabella

A = (mm)	L = (mm)	D = (mm)	B = (mm)	E = (mm)
600	900	-	-	500
650	975	-	-	550
700	1050	-	-	600
750	1125	-	-	650
800	1200	-	-	700
850	1275	-	-	750
900	1350	-	-	800
950	1425	-	-	850
1000	1500	-	-	900
1100	1650	1000	550	
1200	1800	1100	600	
1300	1950	1200	650	
1400	2100	1300	700	
1500	2250	1400	750	
1600	2400	1500	800	
1700	2550	1600	850	
1800	2700	1700	900	

**OPERATORE OP93 3 ANTE TELESCOPICO 3AT**  
**TELESCOPIC OP93 3 SIDE DOOR OPERATOR 3AT**

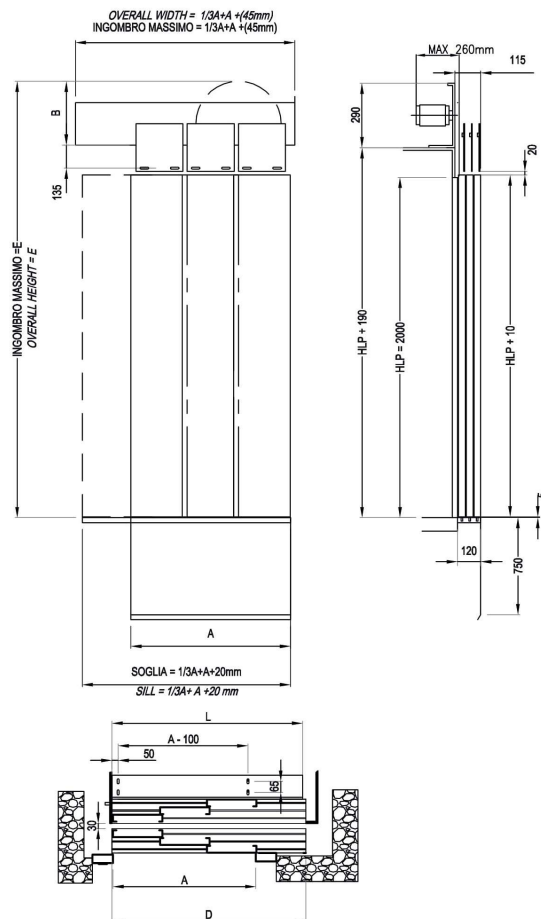
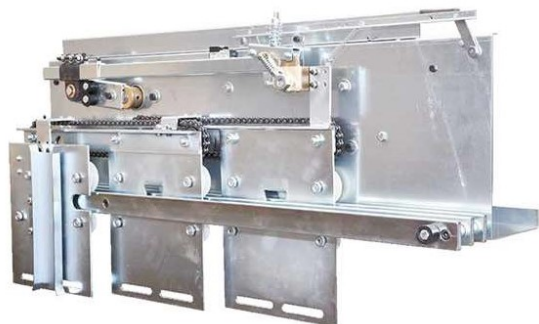

Tabella

A = (mm)	L = (mm)	D = (mm)	B = (mm)	E = (mm)
750	1000	1010	410	2600
800	1070	1075	420	2610
850	1135	1145	425	2615
900	1200	1210	435	2625
950	1270	1275	445	2635
1000	1335	1345	450	2640
1100	1470	1475	465	2655
1200	1600	1610	485	2675
1300	1735	1745	500	2690
1400	1870	1875	520	2710
1500	2000	2010	535	2725
1600	2135	2145	550	2740
1700	2270	2275	570	2760
1800	2400	2410	585	2775

**OPERATORE OP93 4 ANTE CENTRALI 4AO**  
**CENTRAL PANELS OP93 3 DOOR OPERATOR 4AO**

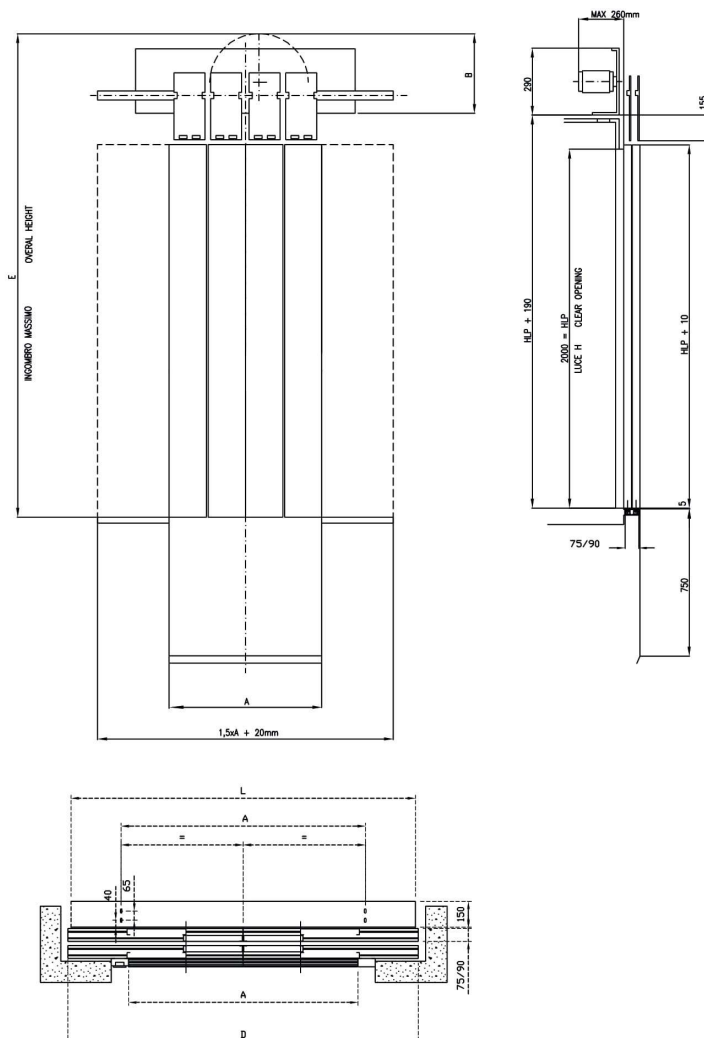
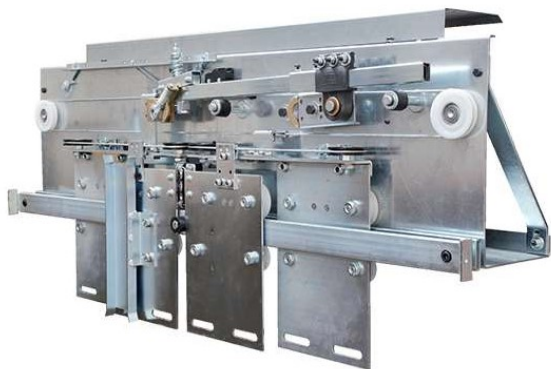

Tabella

A = (mm)	L = (mm)	D = (mm)	B = (mm)	E = (mm)
600	1000	920	410	2600
650	1025	995	410	2600
700	1070	1070	435	2625
750	1125	1145	445	2635
800	1200	1220	460	2650
850	1275	1295	475	2665
900	1350	1370	485	2675
950	1425	1445	500	2690
1000	1500	1520	510	2700
1100	1650	1670	535	2725
1200	1800	1820	560	2750
1300	1950	1970	410	2600
1400	2100	2120	435	2625
1500	2250	2270	445	2635
1600	2400	2420	460	2650
1700	2550	2520	475	2665
1800	2700	2720	485	2675

**OPERATORE FLY 2 ANTE CENTRALI 2AO  
CENTRAL 2 PANELS FLY DOOR OPERATOR 2AO**

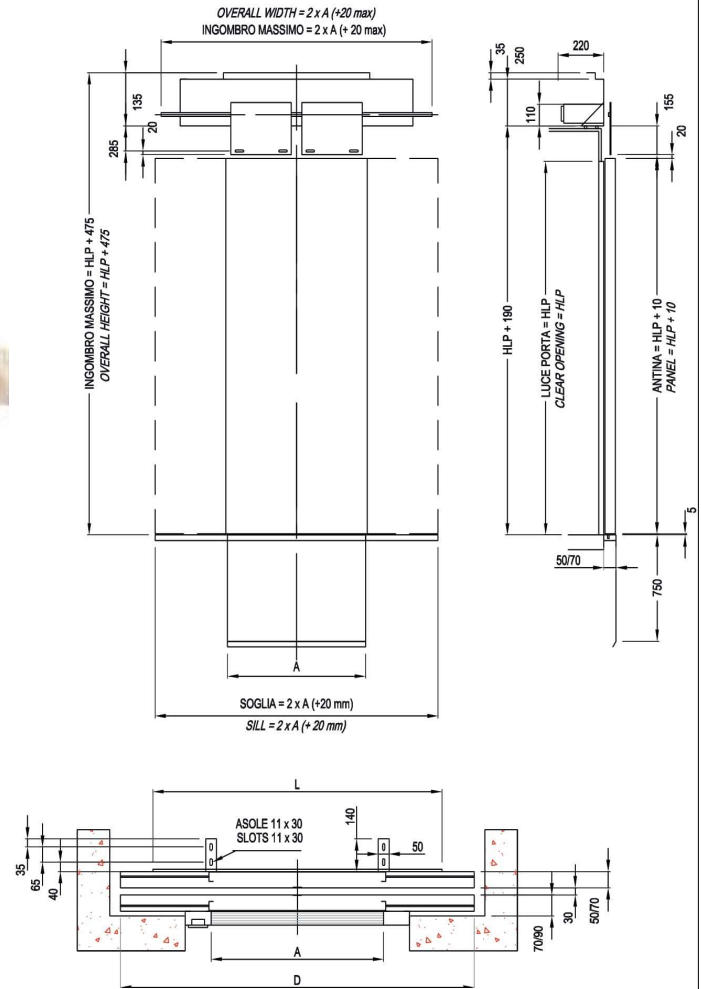

Tabella

A = (mm)	L = (mm)	D = (mm)
600	1100	1220
650	1100	1320
700	1250	1420
750	1250	1520
800	1500	1620
850	1500	1720
900	1500	1820
950	1500	1920
1000	2000	2020

**OPERATORE FLY 2 ANTE TELESCOPICO 2AT  
TELESCOPIC FLY SIDE DOOR OPERATOR 2AT**

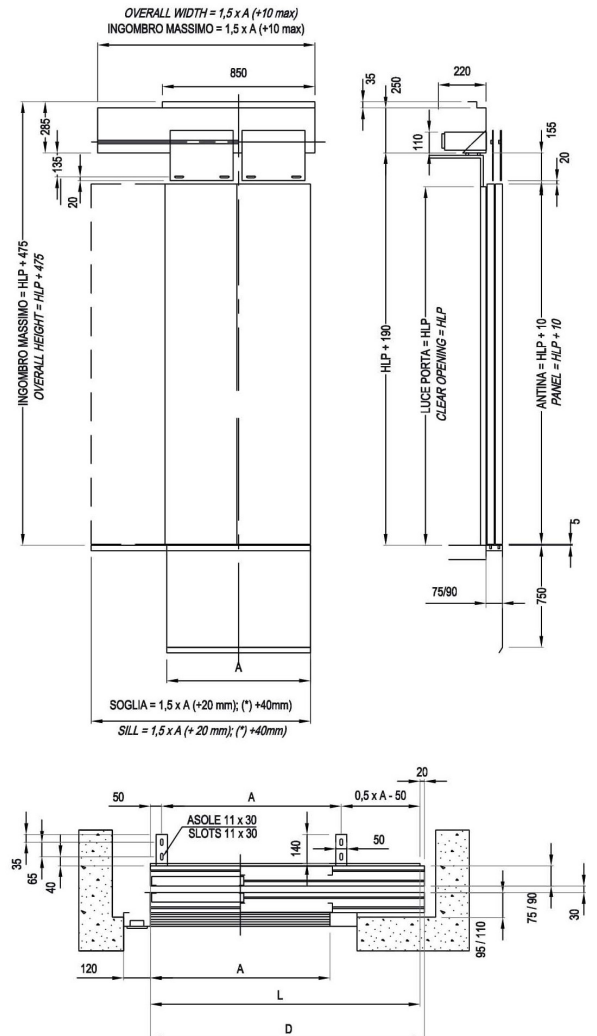

Tabella

A = (mm)	L = (mm)	D = (mm)
600	900	940
650	975	1015
700	1050	1090
750	1125	1165
800	1200	1240
850	1270	1315
900	1350	1390
950	1425	1465
1000	1500	1540

**OPERATORE FLY 3 ANTE TELESOPICO 3AT  
TELESCOPIC FLY 3 SIDE DOOR OPERATOR 3 AT**

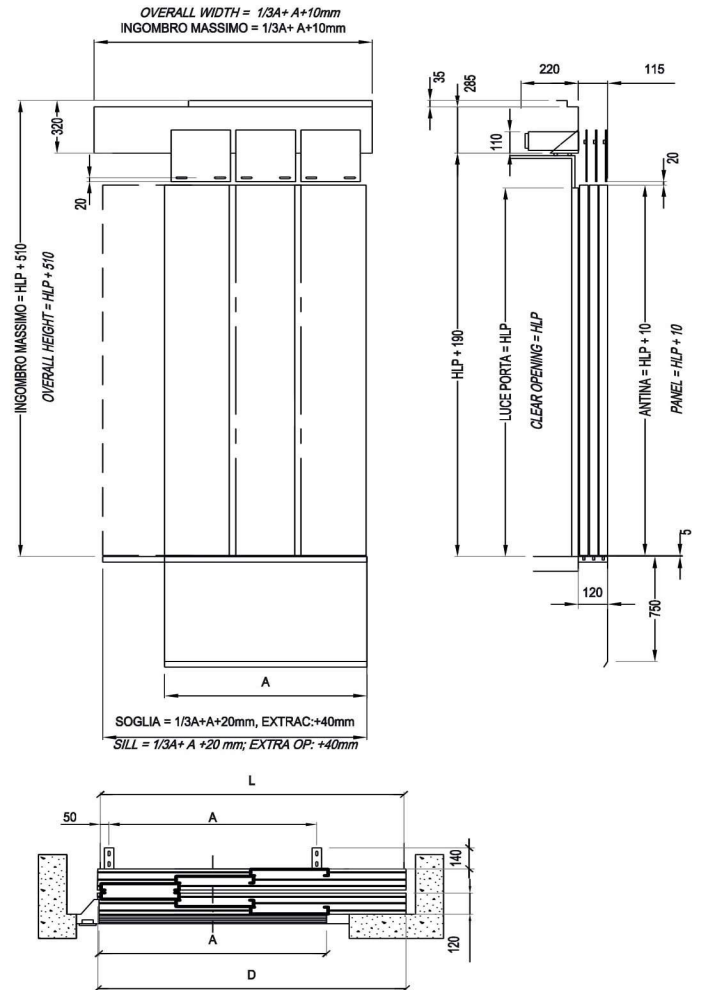

Tabella

A = (mm)	L = (mm)	D = (mm)
750	1000	1020
800	1070	1090
850	1135	1155
900	1200	1220
950	1270	1290
1000	1335	1355

**OPERATORE FLY 4 ANTE CENTRALI 4AO  
CENTRAL 4 PANELS FLY DOOR OPERATOR 4AO**

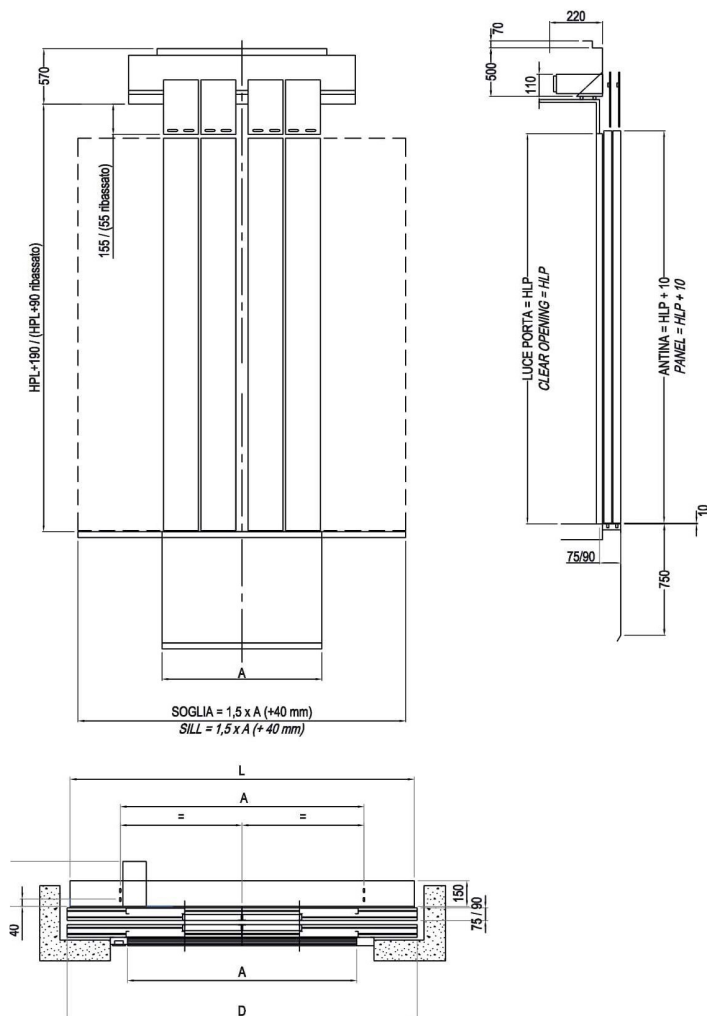
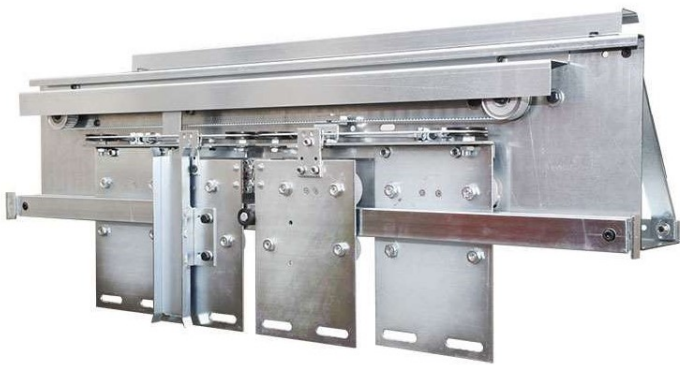

Tabella

A = (mm)	L = (mm)	D = (mm)
600	1000	1025
650	1025	1055
700	1070	1100
750	1125	1150
800	1200	1220
850	1275	1290
900	1350	1360
950	1440	1440
1000	1500	1525



**OPERATORE LIKE 2 ANTE CENTRALI 2AO  
CENTRAL 2 PANELS LIKE DOOR OPERATOR 2AO**

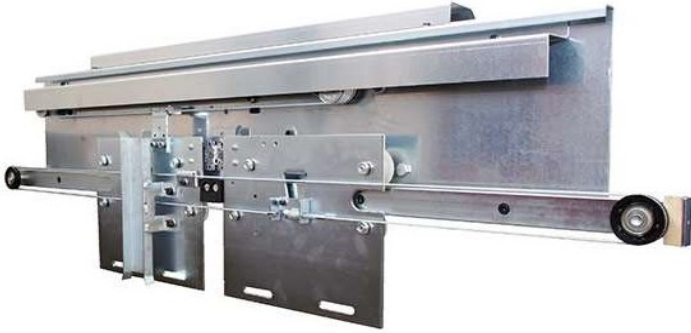

Tabella

A=[mm]	L=[mm]	D=[mm]
600	1100	1220
650	1100	1320
700	1250	1420
750	1250	1520
800	1500	1620
850	1500	1720
900	1500	1820
950	1500	1920
1000	2000	2020
1100	2000	2220
1200	2000	2420
1300	2000	2620
1400	2000	2820

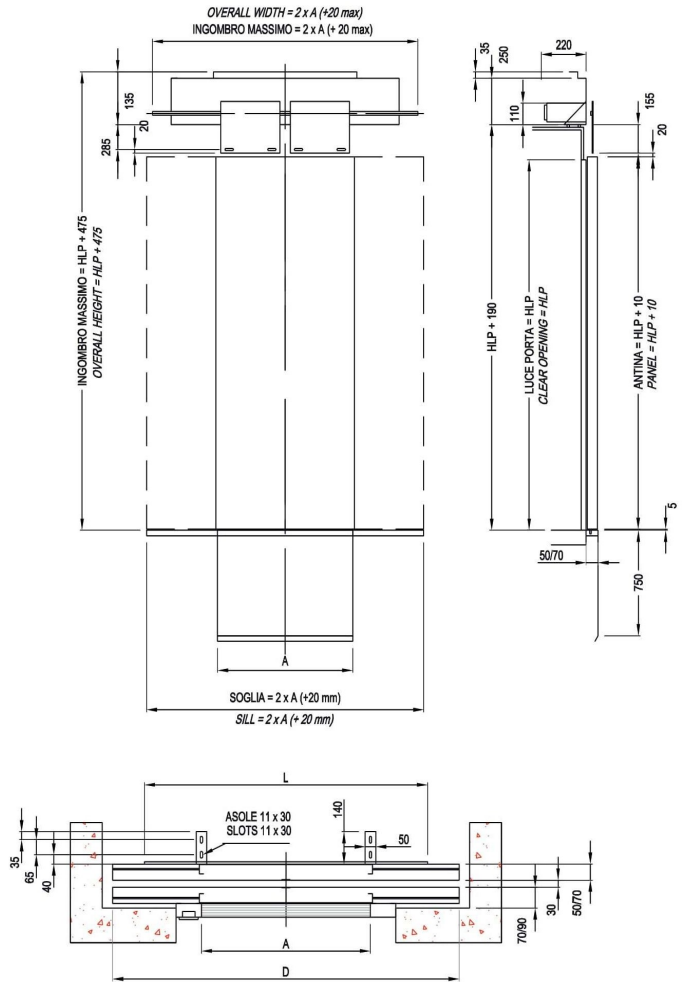

**OPERATORE LIKE 2 ANTE TELESCOPICHE 2AT  
TELESCOPIC LIKE 2 SIDE DOOR OPERATOR 2AT**



Tabella

A=[mm]	L=[mm]	D=[mm]
600	900	940
650	975	1015
700	1050	1090
750	1125	1165
800	1200	1240
850	1270	1315
900	1350	1390
950	1425	1465
1000	1500	1540
1100	1650	1690
1200	1800	1840
1300	1950	1990
1400	2100	2140

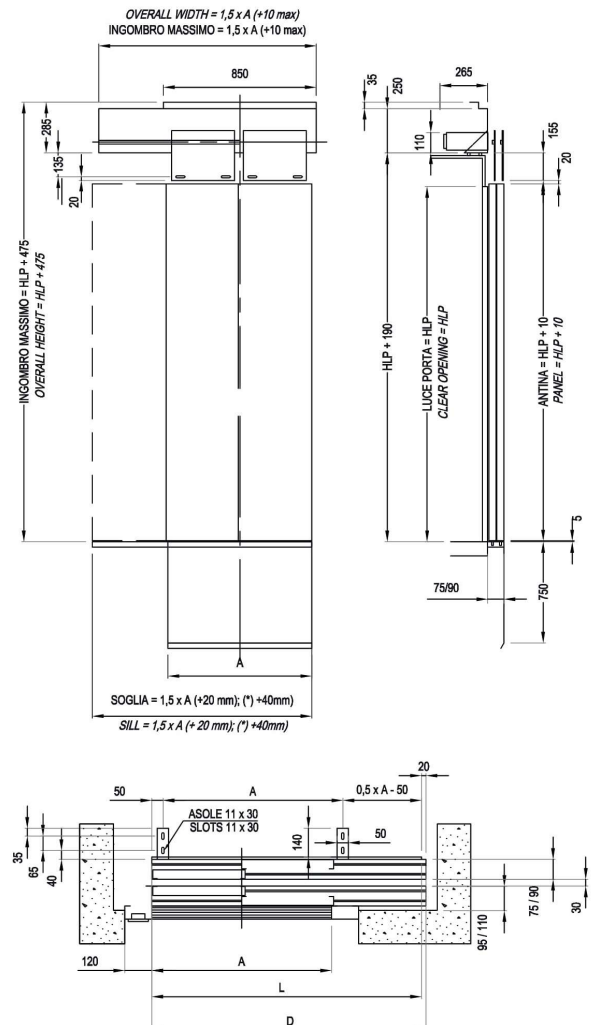

**OPERATORE LIKE 3 ANTE TELESCOPICO 3AT  
TELESCOPIC LIKE 3 SIDE DOOR OPERATOR 3AT**

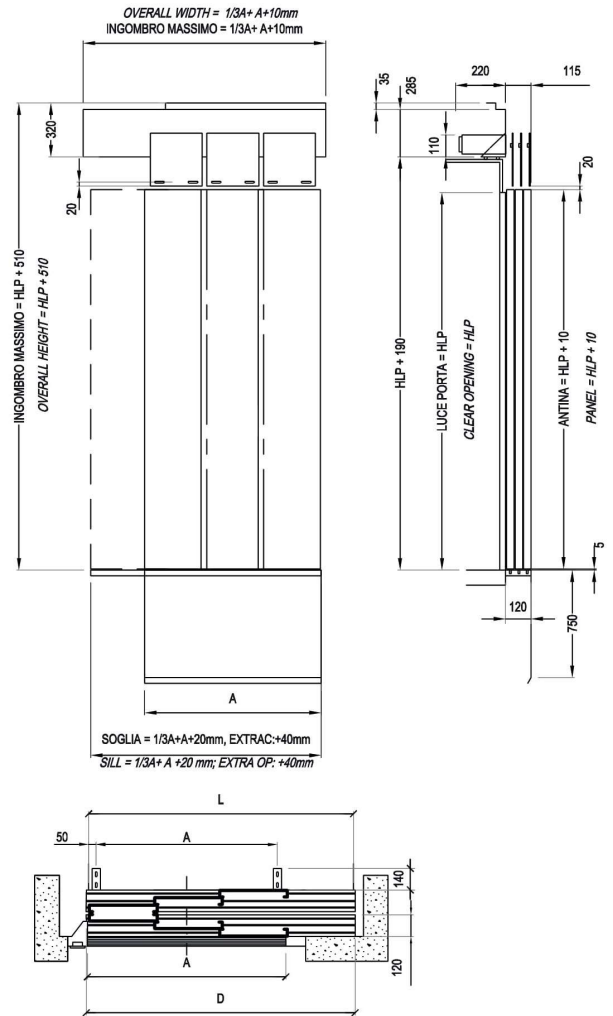

Tabella

A=[mm]	L=[mm]	D=[mm]
750	1000	1020
800	1070	1090
850	1135	1155
900	1200	1220
950	1270	1290
1000	1355	1355

**OPERATORE LIKE 4 ANTE CENTRALI 4AO  
CENTRAL 4 PANELS LIKE DOOR OPERATOR 4AO**

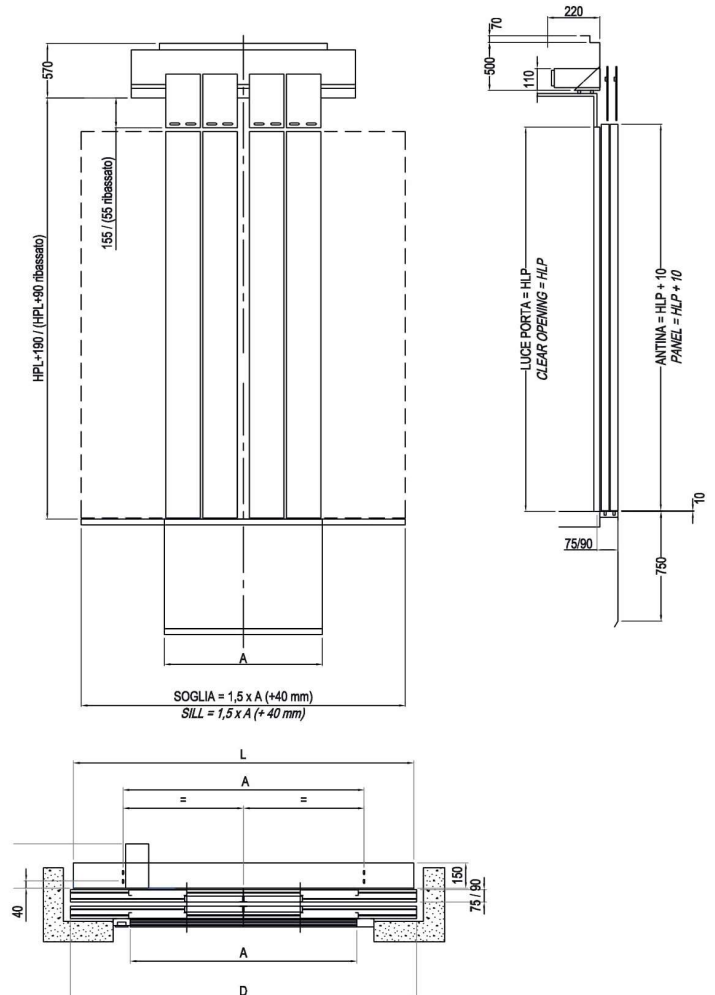

Tabella

A = (mm)	L = (mm)	D = (mm)
600	1000	1025
650	1025	1055
700	1070	1100
750	1125	1150
800	1200	1220
850	1275	1290
900	1350	1360
950	1440	1440
1000	1500	1525
1100		
1200		
1300		
1400		
1500		

**SOSPENSIONE 2 ANTE CENTRALI 2AO  
CENTRAL LANDING MECHANISM 2 PANELS 2AO**



Tabella	
Apertura porta A=[mm]	Altezza massima=[mm]
500 - 750	2000



**SOSPENSIONE 2 ANTE TELESCOPICHE 2AT  
TELESCOPIC LANDING MECHANISM 2 PANELS 2AT**

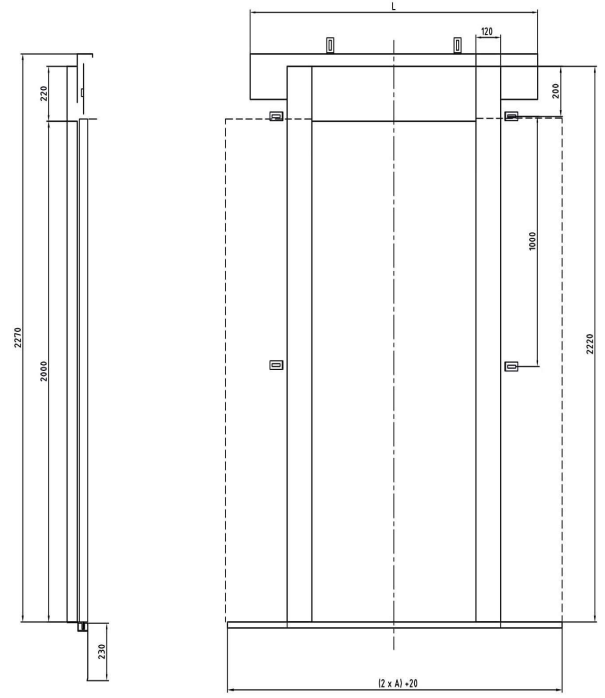
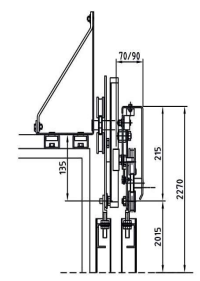
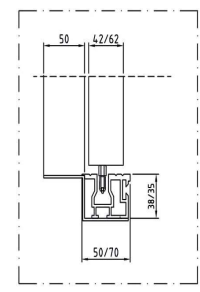

Tabella	
Apertura porta A=[mm]	Altezza massima=[mm]
500 - 750	2000
800 - 1150	2200
1200 - 1800	3000



SOSPENSIONE 3 ANTE TELESCOPICHE 3AT  
TELESCOPIC LANDING MECHANIM 3 PANELS 3AT

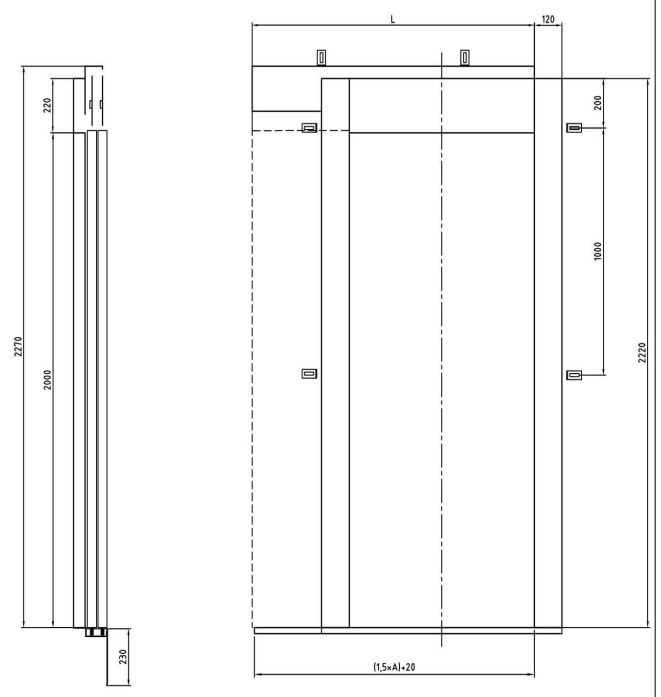
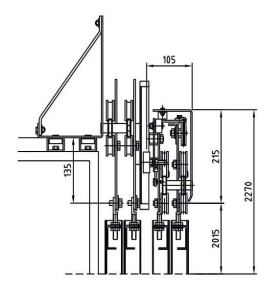
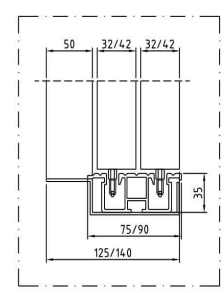

Tabella	
Apertura Porta =[mm]	Altezza Massima =[mm]
750 - 1100	2000
1200 - 1800	2200



SOSPENSIONE 4 ANTE CENTRALI 4AO  
TELESCOPIC LANDING MECHANEM 4 PANELS 4AT

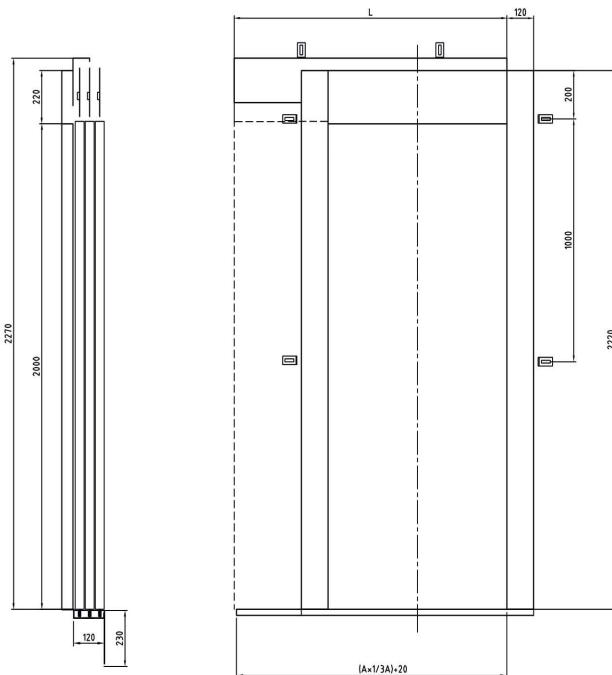
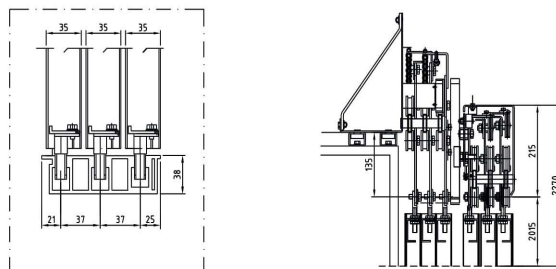

Tabella	
Apertura porta A=[mm]	Altezza massima=[mm]
500 - 750	2000
800 - 1150	2200
1200 - 1800	3000



# MATERIALI PORTE AUTOMATICHE DI PIANO

## AUTOMATIC LANDING DOORS MATERIAL

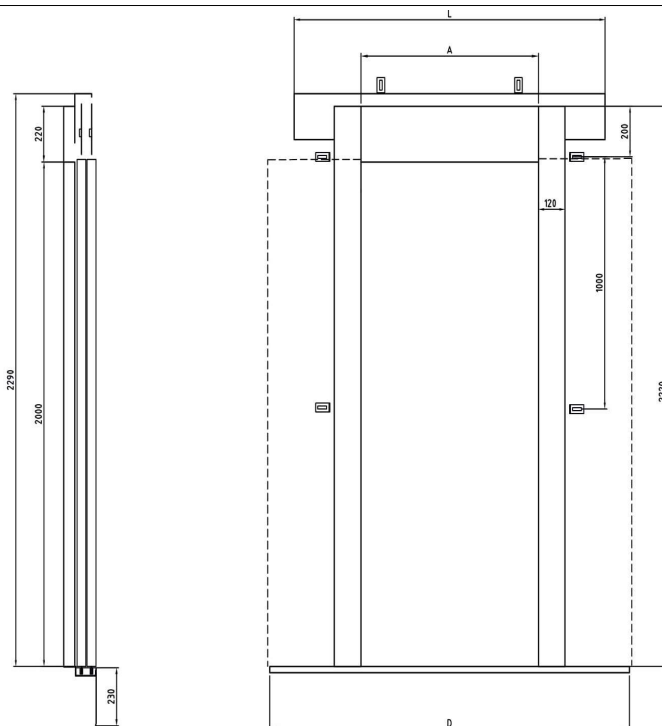
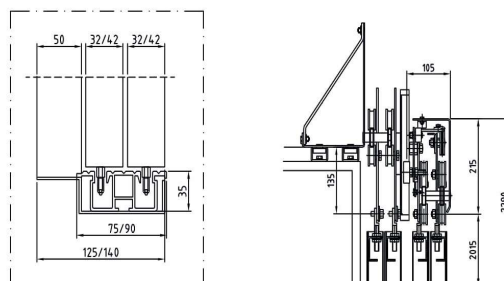
ACCIAIO INOX AISI 441 - AISI 304 - AISI 316  
STAINLESS STEEL AISI 441 - AISI 304 - AISI 1316

**INOX SATINATO**



**INOX SCHOTCH BRITE**



**INOX LUCIDO BA**



**INOX LINO**



**INOX QUADRO**



**DAMA**



**INOX PELLE**



**INOX 5WL**



## RAL STANDARD E LAMIERA PLASTIFICATA

### RAL STANDARD AND SKINPLATE

**RAL 9002**



**AVORIO**



**GRIGIO CHIARO - N1**



**GRIGIO SCURO - N4**



**F12PPS**



**F42PPS**



**PPS10**



**PPS11**



**AZZURRO**



**VERDE CHIARO**



**F21SMA**



**BIANCO LUCIDO A32pp**



RAL 0001	RAL 0003	RAL 9016	RAL 1013	RAL 1015	RAL 1016	RAL 1023
RAL 1003	RAL 1006	RAL 1007	RAL 2003	RAL 2004	RAL 2002	RAL 3020
RAL 3000	RAL 3001	RAL 3003	RAL 3011	RAL 3015	RAL 4003	RAL 4005
RAL 5012	RAL 5015	RAL 5017	RAL 5005	RAL 5010	RAL 5013	RAL 6018
RAL 6011	RAL 6029	RAL 6005	RAL 8003	RAL 8024	RAL 8011	RAL 8016
RAL 8017	RAL 7035	RAL 7040	RAL 7001	RAL 7015	RAL 8019	RAL 9005

## TELAI DI DIMENSIONI SPECIALI - SPECIAL FRAME DIMENSION



PULSANTI - BUTTONS

Venus 2.0



Ercole



BM Macro



Ulisse



Italo



Giunone



Achille



Panzer



PULSANTIERE - PUSHBUTTONS

Soft



Standard



Gilda



Aida



Easy Mod



Bugatti



Venice



Venice Touch



Display

Iris



Iris Excellence



Display LCD di Cabina



Displ



AJC è specializzata in ammodernamento e trasformazioni di ogni tipo di ascensore, marca e modello in conformità della direttiva UNI 10411 e nel rispetto delle normative vigenti.

AJC specializes in modernizing and transforming all types of lifts, brands and models in compliance with the UNI 10411 directive and the laws in force.

